



2022  
**COLORADO**

# Choose your adventure.

The 2022 Colorado delivers everything you could ask for in a midsize pickup. Engine choices that are powerful and efficient, including an available GM-exclusive Duramax® 2.8L Turbo-Diesel engine that provides up to 7,700 lbs. of towing<sup>1,2</sup> muscle. A ZR2 off-road beast with the capability to conquer tough trails. And a comfortable interior filled with convenience and technology features. So go ahead. Choose your best life in Colorado.



Colorado Crew Cab LT in Cherry Red Tintcoat<sup>3</sup> (extra-cost color) and Colorado Crew Cab Z71 in Bright Blue Metallic (extra-cost color). Both shown with available Trail Boss Package<sup>2</sup>. Vehicles shown can tow up to 5,000 lbs.<sup>2,4</sup>

<sup>1</sup> Requires Colorado Crew Cab Short Box LT 2WD with available Trailering Package, LT Convenience Package and Safety Package. <sup>2</sup> Maximum trailering ratings are intended for comparison purposes only. Before you buy a vehicle or use it for trailering, carefully review the Trailering section of the Owner's Manual. The trailering capacity of your specific vehicle may vary. The weight of passengers, cargo and options or accessories may reduce the amount you can trailer. <sup>3</sup> Limited availability. <sup>4</sup> Requires available Trailering Package and automatic locking rear differential on LT; requires available Trailering Package on Z71.



## INTRODUCING COLORADO

### Colorado at a glance.

- Four models: WT, LT, Z71 and ZR2
- Extended Cab or Crew Cab
- Three engines
  - 2.5L 4-cylinder
  - 3.6L V6
  - Duramax 2.8L Turbo-Diesel
- 30 MPG highway<sup>1</sup> with available diesel engine
- 7,700 lbs. maximum trailering weight<sup>2</sup> with available diesel engine
- Apple CarPlay<sup>®3</sup> and Android Auto<sup>™4</sup> compatibility
- Available ZR2 Bison Edition includes
  - 17-inch AEV-designed aluminum wheels
  - AEV front bumper with winch provisions
  - AEV rear bumper with recovery points
  - Five AEV hot-stamped boron steel skid plates
  - AEV fender flares
  - Fog lamps
  - Front and rear floor liners with AEV logo
  - AEV embroidered head restraints
- Available Trail Boss Package<sup>5</sup> includes
  - 17-inch high-gloss Black-painted aluminum wheels
  - Red recovery hooks<sup>6</sup>
  - Black Chevrolet tailgate lettering
  - Black Colorado badges and Chevrolet bowtie emblems
  - Front 1-inch leveling kit
  - Performance front and mid skid plates



Professional driver. Closed course.

Colorado Crew Cab ZR2 in Sand Dune Metallic with available ZR2 Dusk Special Edition.



Colorado Crew Cab LT in Cherry Red Tintcoat<sup>5</sup> (extra-cost color) with available Trail Boss Package<sup>5</sup>

<sup>1</sup> EPA-estimated MPG city/highway: Colorado 2WD with available Duramax 2.8L Turbo-Diesel engine 20/30. <sup>2</sup> Requires Colorado Crew Cab Short Box LT 2WD with available Trailering Package, LT Convenience Package and Safety Package. Maximum trailering ratings are intended for comparison purposes only. Before you buy a vehicle or use it for trailering, carefully review the Trailering section of the Owner's Manual. The trailering capacity of your specific vehicle may vary. The weight of passengers, cargo and options or accessories may reduce the amount you can trailer. <sup>3</sup> Vehicle user interface is a product of Apple and its terms and privacy statements apply. Requires compatible iPhone and data plan rates apply. <sup>4</sup> Vehicle user interface is a product of Google and its terms and privacy statements apply. Requires the Android Auto app on Google Play and a compatible Android smartphone. Data plan rates apply. You can check which smartphones are compatible at [g.co/androidauto/requirements](http://g.co/androidauto/requirements). <sup>5</sup> Limited availability. <sup>6</sup> To avoid the risk of injury, never use recovery hooks to tow a vehicle. For more information, see the Recovery Hooks section of your Owner's Manual.

Apple CarPlay, iPhone, Siri and Apple Music are trademarks of Apple Inc., registered in the U.S. and other countries. Android, Google Play and Android Auto are trademarks of Google LLC.

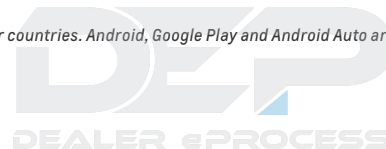

## MODELS

# Four models to choose from.

Colorado is everything you need in a midsize pickup, but make sure to add everything you want.



### WT

Always ready, willing and able to work.

- 2.5L 4-cylinder engine (Extended Cab and Crew Cab Short Box 2WD)
- 3.6L V6 engine (Crew Cab Long Box 2WD and Crew Cab 4x4)
- 4-wheel antilock disc brakes
- CornerStep rear bumper
- Locking tailgate
- Recovery hooks<sup>1</sup> (4x4)
- Cargo area lighting
- 4-way power-adjustable driver seat
- Dual rear seats (Extended Cab)
- Folding rear bench seat (Crew Cab)
- Front center floor console
- Chevrolet Infotainment 3 system<sup>2</sup> with 7-inch diagonal color touch-screen
- Two USB ports<sup>3</sup>

Custom Special Edition available



### LT

Take a step forward in comfort and style.

- Body-color rear bumper, mirror caps and door handles
- Power-adjustable outside mirrors
- 17-inch aluminum wheels
- EZ Lift power locking tailgate
- Remote Keyless Entry
- 6-way power-adjustable driver seat
- Leather-wrapped steering wheel
- Inside rearview auto-dimming mirror
- Overhead console
- Chevrolet Infotainment 3 system<sup>2</sup> with 8-inch diagonal color touch-screen
- Two charge-only USB ports<sup>3</sup> on rear of center console
- Cruise control

Trail Boss Package<sup>4</sup> available

Redline Edition available



### Z71

Leave the paved roads behind.

- 3.6L V6 engine
- Z71 Off-Road Suspension Package
- Automatic locking rear differential
- Hill Descent Control
- Transfer case shield (4x4)
- 17-inch bright machined-aluminum wheels and all-terrain tires
- Black Chevrolet bowtie emblems
- Projector-beam headlamps
- Fog lamps
- Remote vehicle starter system
- Heated steering wheel
- Automatic climate control
- HD Rear Vision Camera<sup>5</sup>

Trail Boss Package<sup>4</sup> available

Z71 Midnight Edition available



### ZR2

Off-road warrior that's on-road capable.

- ZR2 Off-Road Package
- Multimatic DSSV™ Damping System
- Front and rear full locking differentials
- Increased clearance and track width compared to other trim levels
- Tubular rockers and skid plates
- Transfer case shield
- 17-inch Graphite and Oxide Gold aluminum wheels and all-terrain tires
- Off-Road Appearance Package
- Distinctive hood, front fascia and grille
- Spray-on bedliner with ZR2 logo
- Front and rear wheel flares
- Leather-appointed front seats

ZR2 Bison Edition available

ZR2 Dusk Special Edition available

ZR2 Midnight Special Edition available

<sup>1</sup> To avoid the risk of injury, never use recovery hooks to tow a vehicle. For more information, see the Recovery Hooks section of your Owner's Manual. <sup>2</sup> Chevrolet Infotainment System functionality varies by model. Full functionality requires compatible Bluetooth and smartphone, and USB connectivity for some devices. <sup>3</sup> Not compatible with all devices. <sup>4</sup> Limited availability. <sup>5</sup> Safety or driver assistance features are no substitute for the driver's responsibility to operate the vehicle in a safe manner. Read the vehicle Owner's Manual for important feature limitations and information.

## MODEL AVAILABILITY

● AVAILABLE – NOT AVAILABLE

### EXTENDED CAB



TRIM	2WD	4x4	STANDARD ENGINE	AVAILABLE ENGINES	MAX PAYLOAD RATING (LBS.) <sup>1</sup>	MAX TRAILERING WEIGHT RATING (LBS.) <sup>2</sup>
WT	●	–	2.5L I-4	3.6L V6	1,530 <sup>3</sup>	7,000 <sup>3,4</sup>
WT	–	●	2.5L I-4	3.6L V6	1,500 <sup>3</sup>	7,000 <sup>3,4</sup>
LT	●	–	2.5L I-4	3.6L V6	1,530 <sup>3</sup>	7,000 <sup>3,4</sup>
LT	–	●	2.5L I-4	3.6L V6	1,490 <sup>3</sup>	7,000 <sup>3,4</sup>
Z71	–	●	3.6L V6	–	1,460	7,000 <sup>4</sup>
ZR2	–	●	3.6L V6	Duramax 2.8L I-4	1,350 <sup>5</sup>	5,000

### CREW CAB SHORT BOX



TRIM	2WD	4x4	STANDARD ENGINE	AVAILABLE ENGINES	MAX PAYLOAD RATING (LBS.) <sup>1</sup>	MAX TRAILERING WEIGHT RATING (LBS.) <sup>2</sup>
WT	●	–	2.5L I-4	3.6L V6	1,540 <sup>3</sup>	7,000 <sup>3,4</sup>
WT	–	●	3.6L V6	–	1,530	7,000 <sup>4</sup>
LT	●	–	2.5L I-4	3.6L V6, Duramax 2.8L I-4	1,540 <sup>3</sup>	7,700 <sup>4,6</sup>
LT	–	●	3.6L V6	Duramax 2.8L I-4	1,500 <sup>5</sup>	7,600 <sup>4,6</sup>
Z71	●	–	3.6L V6	–	1,490 <sup>5</sup>	7,000 <sup>4</sup>
Z71	–	●	3.6L V6	Duramax 2.8L I-4	1,450 <sup>5</sup>	7,600 <sup>4,6</sup>
ZR2	–	●	3.6L V6	Duramax 2.8L I-4	1,240 <sup>5</sup>	5,000

### CREW CAB LONG BOX



TRIM	2WD	4x4	STANDARD ENGINE	AVAILABLE ENGINES	MAX PAYLOAD RATING (LBS.) <sup>1</sup>	MAX TRAILERING WEIGHT RATING (LBS.) <sup>2</sup>
WT	●	–	3.6L V6	–	1,480 <sup>5</sup>	7,000 <sup>4</sup>
WT	–	●	3.6L V6	–	1,460 <sup>5</sup>	7,000 <sup>4</sup>
LT	●	–	3.6L V6	–	1,480 <sup>5</sup>	7,000 <sup>4</sup>
LT	–	●	3.6L V6	Duramax 2.8L I-4	1,450 <sup>5</sup>	7,600 <sup>4,6</sup>
Z71	–	●	3.6L V6	Duramax 2.8L I-4	1,400 <sup>5</sup>	7,600 <sup>4,6</sup>

<sup>1</sup> These maximum payload ratings are intended for comparison purposes only. Before you buy a vehicle or use it to haul people or cargo, carefully review the Vehicle Loading section of the Owner's Manual and check the carrying capacity of your specific vehicle on the label on the inside of the driver door jamb. <sup>2</sup> Maximum trailering ratings are intended for comparison purposes only. Before you buy a vehicle or use it for trailering, carefully review the Trailering section of the Owner's Manual. The trailering capacity of your specific vehicle may vary. The weight of passengers, cargo and options or accessories may reduce the amount you can trailer. <sup>3</sup> Requires available 3.6L V6 engine. <sup>4</sup> Requires available Trailering Package. <sup>5</sup> Requires 3.6L V6 engine. <sup>6</sup> Requires available Duramax 2.8L I-4 engine.



## STANDARD EQUIPMENT

Standard on every Colorado:

### MECHANICAL

**Battery** – with rundown protection and retained accessory power

**Brakes** – 4-wheel antilock disc with Duralife® rotors

**Frame** – fully boxed

**StabiliTrak®** – Electronic Stability Control System and Traction Control; includes Hill Start Assist

**Steering** – rack-and-pinion with Electric Power Steering (EPS) assist

### EXTERIOR

**Bumper** – rear CornerSteps (excludes ZR2)

**Cargo box light** – back of cab

**Daytime running lamps**

**Fuel filler** – capless fueling (gas engine)

**Headlamps** – halogen with automatic on/off with automatic delay; projector-beam on Z71 and ZR2

**Moldings** – Black beltline

### INTERIOR

**Airbags**<sup>1</sup> – dual-stage frontal airbags for driver and front passenger; seat-mounted side-impact airbags for driver and front passenger; head-curtain airbags for front and rear outboard seating positions; includes front Passenger Sensing System for frontal passenger airbag

**Audio** – 6-speaker system

**Connectivity** – Bluetooth® phone connectivity and wireless audio streaming<sup>2</sup>

**Console** – front center floor

**Door locks** – power programmable with lockout protection and rear door child security

**Driver Information Center**

**Floor mats** – front and rear, carpeted

**Instrument cluster** – with speedometer, fuel level, engine temperature and tachometer

**Media** – two USB ports<sup>3</sup> and auxiliary input jack in front center floor console

**Power outlet** – 12-volt auxiliary, front

**Seats** – front bucket  
– dual rear with underseat storage (Extended Cab)  
– rear folding bench (Crew Cab)

**SiriusXM®**<sup>4</sup> – 3-month trial subscription

**Teen Driver technology**<sup>5</sup>

**Temperature display** – outside

**Theft-deterrent system** – engine immobilizer

**Tire Pressure Monitoring System** – with Tire Fill Alert (does not apply to spare tire)

**Windows** – power with driver express-up/-down, all others express-down

<sup>1</sup> A NOTE ON CHILD SAFETY: Always use seat belts and the correct child restraint for your child's age and size, even with airbags. Even in vehicles equipped with the Passenger Sensing System, children are safer when properly secured in a rear seat in the appropriate infant, child or booster seat. Never place a rear-facing infant restraint in the front seat of any vehicle equipped with an active frontal airbag. See your vehicle Owner's Manual and the child safety seat instructions for more safety information. <sup>2</sup> Go to [my.chevrolet.com/learnAbout/bluetooth](http://my.chevrolet.com/learnAbout/bluetooth) to find out which phones are compatible with the vehicle. Full Bluetooth feature functionality varies by device, model and software version. <sup>3</sup> Not compatible with all devices. <sup>4</sup> If you decide to continue service after your trial, your selected subscription plan will automatically renew thereafter. You will be charged at then-current rates. Fees and taxes apply. To cancel you must call SiriusXM at 1-866-635-2349. See SiriusXM Customer Agreement for complete terms at [siriusxm.com](http://siriusxm.com). All fees and programming subject to change. <sup>5</sup> Safety or driver assistance features are no substitute for the driver's responsibility to operate the vehicle in a safe manner. Read the vehicle Owner's Manual for important feature limitations and information.



## ENGINE SPECIFICATIONS



### 2.5L DOHC I-4

Standard on WT and LT Extended Cab, and WT and LT Crew Cab Short Box 2WD.

6-speed automatic transmission

200 hp @ 6300 rpm

191 lb.-ft. of torque @ 4400 rpm

Displacement: 2460 cc (150 cu. in.)

Bore and stroke: 88 mm x 101 mm (3.46 in. x 3.97 in.)

Compression ratio: 11.3:1

Block: Cast-aluminum

Cylinder head: Cast-aluminum

Valvetrain: Dual-overhead camshafts with 4 valves per cylinder and Variable Valve Timing (VVT)

Fuel delivery: Direct Injection

Max payload rating: 1,420 lbs.<sup>1,2</sup>

Max trailering weight rating: 3,500 lbs.<sup>3</sup>

EPA-estimated fuel economy – 2WD: 19 MPG city/25 highway

EPA-estimated fuel economy – 4x4: 19 MPG city/24 highway



### 3.6L DOHC V6

Standard on WT and LT Crew Cab Short Box 4x4, WT and LT Crew Cab Long Box, Z71, and ZR2.

8-speed automatic transmission

308 hp @ 6800 rpm

275 lb.-ft. of torque @ 4000 rpm

Displacement: 3640 cc (222 cu. in.)

Bore and stroke: 95 mm x 85.6 mm (3.74 in. x 3.37 in.)

Compression ratio: 11.5:1

Block: Cast-aluminum

Cylinder head: Cast-aluminum

Valvetrain: Dual-overhead camshafts with 4 valves per cylinder and Variable Valve Timing (VVT)

Fuel delivery: Direct Injection

Max payload rating: 1,540 lbs.<sup>1,4</sup>

Max trailering weight rating: 7,000 lbs.<sup>3,5</sup>

EPA-estimated fuel economy – 2WD: 18 MPG city/25 highway

EPA-estimated fuel economy – 4x4: 17 MPG city/24 highway

EPA-estimated fuel economy – ZR2: 16 MPG city/18 highway



### DURAMAX 2.8L TURBO-DIESEL I-4

Available on LT Crew Cab Short Box, LT Crew Cab Long Box 4x4, Z71 Crew Cab 4x4 and ZR2.

6-speed automatic transmission

181 hp @ 3400 rpm

369 lb.-ft. of torque @ 2000 rpm

Displacement: 2776 cc (169 cu. in.)

Bore and stroke: 94 mm x 100 mm (3.70 in. x 3.94 in.)

Compression ratio: 16.5:1

Block: Cast-iron

Cylinder head: Cast-aluminum

Valvetrain: Dual-overhead camshafts with 4 valves per cylinder

Fuel delivery: High-pressure, common rail Direct Injection

Max payload rating: 1,480 lbs.<sup>1,6</sup>

Max trailering weight rating: 7,700 lbs.<sup>3,6</sup>

EPA-estimated fuel economy – 2WD: 20 MPG city/30 highway

EPA-estimated fuel economy – 4x4: 19 MPG city/28 highway

EPA-estimated fuel economy – ZR2: 18 MPG city/22 highway

<sup>1</sup> These maximum payload ratings are intended for comparison purposes only. Before you buy a vehicle or use it to haul people or cargo, carefully review the Vehicle Loading section of the Owner's Manual and check the carrying capacity of your specific vehicle on the label on the inside of the driver door jamb. <sup>2</sup> Requires Colorado Crew Cab LT 2WD. <sup>3</sup> Maximum trailering ratings are intended for comparison purposes only. Before you buy a vehicle or use it for trailering, carefully review the Trailering section of the Owner's Manual. The trailering capacity of your specific vehicle may vary. The weight of passengers, cargo and options or accessories may reduce the amount you can trailer. <sup>4</sup> Requires Colorado Crew Cab Short Box WT 2WD or Colorado Crew Cab Short Box LT 2WD. <sup>5</sup> Requires available Trailering Package. <sup>6</sup> Requires Colorado Crew Cab Short Box LT 2WD.

## WORK TRUCK (WT) EXTERIOR COLORS



Summit White



Satin Steel Metallic



Cherry Red Tintcoat<sup>1,2</sup>



Crush<sup>1,2</sup>



Bright Blue Metallic<sup>1</sup>



Black

<sup>1</sup>Extra-cost color. <sup>2</sup>Limited availability.



## WORK TRUCK (WT) FEATURES



Available on Extended Cab, Crew Cab Short Box and Crew Cab Long Box. In addition to standard equipment, select WT features include:

### MECHANICAL

Engine – 2.5L DOHC 4-cylinder with Variable Valve Timing (VVT) and Direct Injection  
 – 3.6L DOHC V6 with Variable Valve Timing (VVT) and Direct Injection (Crew Cab 4x4 and Crew Cab Long Box 2WD models)

Transfer case – 2-speed, electronic with rotary controls; includes Neutral position for dinghy towing (4x4 models)

Transmission – 6-speed automatic, electronically controlled with overdrive  
 – 8-speed automatic, electronically controlled with overdrive, Tow/Haul mode and Hitch Guidance<sup>1</sup> (Crew Cab 4x4 and Crew Cab Long Box 2WD models)

### EXTERIOR

Mirrors – manual-adjustable, manual-folding with Black caps

Recovery hooks<sup>2</sup> – front (4x4 models)

Tires – 255/65R17 all-season

### INTERIOR

Air conditioning – manual, single-zone

Entertainment – Chevrolet Infotainment 3 system<sup>3</sup> with 7-inch diagonal color touch-screen

Rear Vision Camera<sup>1</sup>

Seat – driver 4-way power adjuster with manual recline

Steering column – manual tilt



Dark Ash Vinyl (shown)



Dark Ash Cloth



17" Ultra Silver Metallic-Painted Steel Wheels  
Standard on WT



18" Dark Argent Metallic-Painted Aluminum Wheels  
Available on WT with Custom Special Edition

<sup>1</sup> Safety or driver assistance features are no substitute for the driver's responsibility to operate the vehicle in a safe manner. Read the vehicle Owner's Manual for important feature limitations and information. <sup>2</sup> To avoid the risk of injury, never use recovery hooks to tow a vehicle. For more information, see the Recovery Hooks section of your Owner's Manual. <sup>3</sup> Chevrolet Infotainment System functionality varies by model. Full functionality requires compatible Bluetooth and smartphone, and USB connectivity for some devices.

## LT EXTERIOR COLORS



Summit White



Satin Steel Metallic



Cherry Red Tintcoat<sup>1,2</sup>



Crush<sup>1,2</sup>



Bright Blue Metallic<sup>1</sup>



Black

<sup>1</sup>Extra-cost color. <sup>2</sup>Limited availability.

## LT FEATURES



Available on Extended Cab, Crew Cab Short Box and Crew Cab Long Box. In addition to standard equipment, select LT features include:

### MECHANICAL

Engine – 2.5L DOHC 4-cylinder with Variable Valve Timing (VVT) and Direct Injection

– 3.6L DOHC V6 with Variable Valve Timing (VVT) and Direct Injection (Crew Cab 4x4 and Crew Cab Long Box 2WD models)

Transfer case – 2-speed, electronic Autotrac® with rotary controls; includes Neutral position for dinghy towing (4x4 models)

Transmission – 6-speed automatic, electronically controlled with overdrive

– 8-speed automatic, electronically controlled with overdrive, Tow/Haul mode and Hitch Guidance<sup>1</sup> (Crew Cab 4x4 and Crew Cab Long Box 2WD models)

### EXTERIOR

Mirrors – power-adjustable, manual-folding with body-color caps; includes driver spotter mirror

Recovery hooks<sup>2</sup> – front (4x4 models)

Tires – 255/65R17 all-season

### INTERIOR

Air conditioning – manual, single-zone

Cruise control – electronic with Set and Resume Speed

Entertainment – Chevrolet Infotainment 3 system<sup>3</sup> with 8-inch diagonal color touch-screen

Mirror – rearview, auto-dimming

Rear Vision Camera<sup>4</sup>

Remote Keyless Entry – extended-range

Seat – driver 6-way power adjuster

Steering column – manual tilt and telescopic

Steering wheel – leather-wrapped with mounted audio, cruise and phone controls

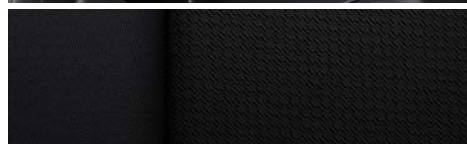

Jet Black Cloth

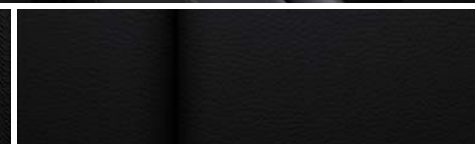

Jet Black Leather-Appointed Front Seating Surfaces<sup>4</sup> (shown)



17" Blade Silver Metallic-Painted Aluminum Wheels  
Standard on LT



17" High-Gloss Black-Painted Aluminum Wheels  
Available on LT with Trail Boss Package<sup>5</sup>



18" Dark Argent Metallic-Painted Aluminum Wheels  
Available on LT



18" Black-Painted Aluminum Wheels with Red Accents  
Available on LT with Redline Edition

<sup>1</sup> Safety or driver assistance features are no substitute for the driver's responsibility to operate the vehicle in a safe manner. Read the vehicle Owner's Manual for important feature limitations and information. <sup>2</sup> To avoid the risk of injury, never use recovery hooks to tow a vehicle. For more information, see the Recovery Hooks section of your Owner's Manual. <sup>3</sup> Chevrolet Infotainment System functionality varies by model. Full functionality requires compatible Bluetooth and smartphone, and USB connectivity for some devices. <sup>4</sup> Available on Crew Cab models only. Requires available Luxury Package. <sup>5</sup> Limited availability.



Some features shown may have limited, late or no availability. See dealer for feature availability.

## Z71 EXTERIOR COLORS



Summit White



Satin Steel Metallic



Sand Dune Metallic



Cherry Red Tintcoat<sup>1,2</sup>



Crush<sup>1,2</sup>



Bright Blue Metallic<sup>1</sup>



Black

<sup>1</sup>Extra-cost color. <sup>2</sup>Limited availability.

## Z71 FEATURES



Available on Extended Cab, Crew Cab Short Box and Crew Cab Long Box. In addition to standard equipment, select Z71 features include:

### MECHANICAL

Differential – automatic locking rear

Engine – 3.6L DOHC V6 with Variable Valve Timing (VVT) and Direct Injection

Transfer case – 2-speed, electronic Autotrac with rotary controls; includes Neutral position for dinghy towing (4x4 models) – transfer case shield (4x4 models)

Transmission – 8-speed automatic, electronically controlled with overdrive, Tow/Haul mode and Hitch Guidance<sup>1</sup>

Z71 Off-Road Suspension Package

### EXTERIOR

Fog lamps

Mirrors – heated, power-adjustable, manual-folding with Black caps; includes driver spotter mirror

Recovery hooks<sup>2</sup> – front

Tires – 255/65R17 all-terrain

### INTERIOR

Air conditioning – automatic, single-zone

Entertainment – Chevrolet Infotainment 3 Plus system<sup>3</sup> with 8-inch diagonal HD color touch-screen

Remote vehicle starter system

Seat – driver 6-way power adjuster and power lumbar control

Steering wheel – heated, leather-wrapped with mounted audio, cruise and phone controls

Window – sliding rear



Jet Black Cloth/Leatherette

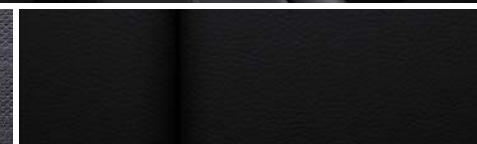

Jet Black Leather-Appointed Front Seating Surfaces<sup>4</sup> (shown)



17" Bright Machined-Aluminum Wheels  
Standard on Z71



17" Gloss Black-Painted Aluminum Wheels  
Available on Z71 with Z71 Midnight Edition



17" High-Gloss Black-Painted Aluminum Wheels  
Available on Z71 with Trail Boss Package<sup>5</sup>

<sup>1</sup> Safety or driver assistance features are no substitute for the driver's responsibility to operate the vehicle in a safe manner. Read the vehicle Owner's Manual for important feature limitations and information. <sup>2</sup> To avoid the risk of injury, never use recovery hooks to tow a vehicle. For more information, see the Recovery Hooks section of your Owner's Manual. <sup>3</sup> Chevrolet Infotainment System functionality varies by model. Full functionality requires compatible Bluetooth and smartphone, and USB connectivity for some devices. <sup>4</sup> Extra-cost interior. Available on Crew Cab models only. <sup>5</sup> Limited availability.



Some features shown may have limited, late or no availability. See dealer for feature availability.

## ZR2 EXTERIOR COLORS



Summit White



Satin Steel Metallic



Sand Dune Metallic



Cherry Red Tintcoat<sup>1,2</sup>



Crush<sup>1,2</sup>



Bright Blue Metallic<sup>1</sup>



Black

<sup>1</sup>Extra-cost color. <sup>2</sup>Limited availability.

## ZR2 FEATURES



Available on Extended Cab and Crew Cab Short Box. In addition to standard equipment, select ZR2 features include:

### MECHANICAL

Differential – full locking front and rear, driver selectable

Engine – 3.6L DOHC V6 with Variable Valve Timing (VVT) and Direct Injection

Trailer Package – trailer hitch and 7-pin connector

Transfer case – 2-speed, electronic Autotrac with rotary controls; includes Neutral position for dinghy towing

Transmission – 8-speed automatic, electronically controlled with overdrive, Tow/Haul mode and Hitch Guidance<sup>1</sup>

### EXTERIOR

Bedliner – Black spray-on with ZR2 logo

Mirrors – heated, power-adjustable, manual-folding with body-color caps; includes driver spotter mirror

Off-road rocker protection

Recovery hooks<sup>2</sup> – Red

Tires – 265/65R17 Goodyear Wrangler DuraTrac<sup>®</sup> all-terrain

ZR2 Off-Road Package – taller and wider stance, Multimatic DSSV™ Damping System, off-road front fascia and rear bumper, fender flares and Chevrolet lettered grille with small flowtie emblem

### INTERIOR

Air conditioning – automatic, single-zone

Entertainment – Chevrolet Infotainment 3 Plus system<sup>3</sup> with 8-inch diagonal HD color touch-screen

Remote vehicle starter system

Seat – driver 6-way power adjuster and power lumbar control  
– front passenger 4-way power adjuster and power lumbar control

Steering wheel – heated, leather-wrapped with mounted audio, cruise and phone controls

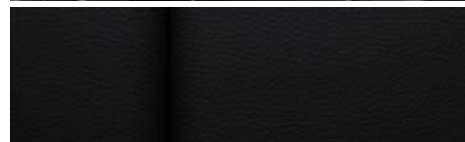

Jet Black Leather-Appointed Front Seating Surfaces (shown)



17" Graphite and Oxide Gold Aluminum Wheels  
Standard on ZR2



17" AEV-Designed Dark Graphite Aluminum Wheels  
Available on ZR2 with ZR2 Bison Edition



17" Gloss Black-Painted Aluminum Wheels  
Available on ZR2 with ZR2 Dusk Special Edition  
or ZR2 Midnight Special Edition

<sup>1</sup> Safety or driver assistance features are no substitute for the driver's responsibility to operate the vehicle in a safe manner. Read the vehicle Owner's Manual for important feature limitations and information. <sup>2</sup> To avoid the risk of injury, never use recovery hooks to tow a vehicle. For more information, see the Recovery Hooks section of your Owner's Manual. <sup>3</sup> Chevrolet Infotainment System functionality varies by model. Full functionality requires compatible Bluetooth and smartphone, and USB connectivity for some devices.



Some features shown may have limited, late or no availability. See dealer for feature availability.

## SPECIFICATIONS

● STANDARD ○ AVAILABLE – NOT AVAILABLE

	WT	LT	Z71	ZR2
<b>SAFETY AND DRIVER ASSISTANCE</b>				
Airbags <sup>1</sup> – dual-stage frontal airbags for driver and front passenger; seat-mounted side-impact airbags for driver and front passenger; head-curtain airbags for front and rear outboard seating positions; includes front Passenger Sensing System for frontal passenger airbag	●	●	●	●
Forward Collision Alert <sup>2</sup> (requires available Safety Package)	–	○	○	–
Lane Departure Warning <sup>2</sup> (requires available Safety Package)	–	○	○	–
Rear Park Assist <sup>2</sup> (models built on or after December 20, 2021, Rear Park Assist will not function on certain models without dealer retrofit, expected Q4 2022; see dealer for details) (requires available WT Convenience Package on WT; requires available Safety Package on LT)	○	○	○	–
Rear Vision Camera <sup>2</sup> HD Rear Vision Camera <sup>2</sup> (requires available Chevrolet Infotainment 3 Plus system <sup>3</sup> with Navigation <sup>4</sup> on LT)	●	●	–	–
Teen Driver technology <sup>2</sup>	●	●	●	●
Theft-deterrent system – engine immobilizer – unauthorized entry (requires available WT Convenience Package on WT)	●	●	●	●
Tire Pressure Monitoring System – with Tire Fill Alert (does not monitor spare tire)	●	●	●	●
Up to 3 months of OnStar <sup>®</sup> Safety & Security coverage <sup>5</sup>	○	●	●	●
<b>MECHANICAL</b>				
Battery – with rundown protection and retained accessory power	●	●	●	●
Brakes – 4-wheel antilock disc with Duralife rotors	●	●	●	●
Differential – automatic locking rear (standard on Crew Cab Long Box WT and LT; available with 2.5L 4-cylinder engine or 3.6L V6 engine on Extended Cab and Crew Cab Short Box WT and LT; required with Duramax 2.8L Turbo-Diesel I-4 engine on Crew Cab Short Box LT; requires available Trailing Package on WT and LT) – driver-selectable full locking front and rear	○	○	●	–

	WT	LT	Z71	ZR2
<b>MECHANICAL (CONTINUED)</b>				
Engine – 2.5L DOHC 4-cylinder with Variable Valve Timing (VVT) and Direct Injection; 200 hp @ 6300 rpm, 191 lb.-ft. of torque @ 4400 rpm (standard on Crew Cab Short Box 2WD and Extended Cab models) – 3.6L DOHC V6 with Variable Valve Timing (VVT) and Direct Injection; 308 hp @ 6800 rpm, 275 lb.-ft. of torque @ 4000 rpm (standard on Crew Cab WT and LT 4x4, and Crew Cab Long Box WT and LT 2WD models) – Duramax 2.8L Turbo-Diesel DOHC I-4 with common rail Direct Injection; 181 hp @ 3400 rpm, 369 lb.-ft. of torque @ 2000 rpm; includes Diesel Exhaust Brake and integrated trailer brake controller (Crew Cab models only; LT requires available Safety Package, LT Convenience Package and Trailing Package; LT 2WD also requires Short Box; Z71 requires available 4x4, Safety Package and Trailing Package)	●	●	–	–
Frame – fully boxed	●	●	●	●
Hill Descent Control	–	–	●	●
StabiliTrak – Electronic Stability Control System and Traction Control; includes Hill Start Assist	●	●	●	●
Steering – rack-and-pinion with Electric Power Steering (EPS) assist	●	●	●	●
Suspension – Z71 Off-Road Package – Multimatic DSSV™ Damping System	–	–	●	–
Tow/Haul mode – includes Hitch Guidance <sup>2</sup> with dynamic trailering assist guideline (standard on Crew Cab Long Box WT and LT; available with 3.6L V6 engine on Extended Cab and Crew Cab Short Box WT and LT; available with Duramax 2.8L Turbo-Diesel I-4 engine on Extended Cab and Crew Cab Short Box LT)	○	○	●	●
Trailer brake controller – integrated (included with available Duramax 2.8L Turbo-Diesel I-4 engine; requires available Trailing Package with 3.6L V6 engine)	○	○	○	●
Transfer case – electric, 2-speed (4x4 models) – electric, 2-speed, Autotrac (4x4 models) – transfer case shield (4x4 models)	●	–	–	–
Transmission – 6-speed automatic, electronically controlled with overdrive (included with 2.5L DOHC 4-cylinder engine and available Duramax 2.8L Turbo-Diesel I-4 engine) – 8-speed automatic, electronically controlled with overdrive (included with 3.6L V6 engine)	●	●	○	○

<sup>1</sup> A NOTE ON CHILD SAFETY: Always use seat belts and the correct child restraint for your child's age and size, even with airbags. Even in vehicles equipped with the Passenger Sensing System, children are safer when properly secured in a rear seat in the appropriate infant, child or booster seat. Never place a rear-facing infant restraint in the front seat of any vehicle equipped with an active frontal airbag. See your vehicle Owner's Manual and the child safety seat instructions for more safety information.

<sup>2</sup> Safety or driver assistance features are no substitute for the driver's responsibility to operate the vehicle in a safe manner. Read the vehicle Owner's Manual for important feature limitations and information. <sup>3</sup> Chevrolet Infotainment System functionality varies by model. Full functionality requires compatible Bluetooth and smartphone, and USB connectivity for some devices. <sup>4</sup> Map coverage available in the United States, Puerto Rico and Canada. <sup>5</sup> When you select a monthly plan within 30 days of activating your 1-month trial, you'll receive the next 2 months of the plan you select at no additional charge when you associate an approved payment method on file to your account and authorize recurring payments for your service plan. The amount and frequency of each recurring payment is based upon the service(s) and payment interval(s) you select from the options provided. After the trial expires, OnStar will automatically bill your payment method monthly at then-current standard monthly rates. Plans containing 4G LTE data will be billed every 30 days by AT&T. You may cancel at any time by pushing your blue OnStar button or calling 1-888-466-7827. May not be combined with other offers or retroactively applied. Offer subject to change.



## SPECIFICATIONS (CONTINUED)

● STANDARD ○ AVAILABLE – NOT AVAILABLE

	WT	LT	Z71	ZR2
<b>EXTERIOR</b>				
Bedliner – Black spray-on with Chevrolet logo; ZR2 includes ZR2 logo	○	○	○	●
Bumper – rear CornerSteps	●	●	●	–
– chrome, rear (requires available Chrome Appearance Package on LT)	●	○	–	–
– body-color, rear (requires available Custom Special Edition on WT)	○	●	●	–
– Black, rear	–	–	–	●
Cargo box light – back of cab	●	●	●	●
Daytime running lamps	●	●	●	●
Door handles – Black (requires available Redline Edition on LT)	●	○	●	–
– body-color (requires available Custom Special Edition on WT)	○	●	–	●
– chrome (requires available Chrome Appearance Package)	–	○	–	–
Fog lamps (requires available LT Convenience Package on LT; requires available ZR2 Bison Edition on ZR2)	–	○	●	○
Fuel filler – capless fueling (gas engine)	●	●	●	●
Grille – chrome front grille bar with Gold bowtie emblem	●	–	–	–
– Black front grille bar with Gold bowtie emblem	–	●	–	–
– chrome front grille bar with Black bowtie emblem and small Z71 badge	–	–	●	–
– Chevrolet lettered grille with small flowtie emblem	–	–	–	●
Headlamps – halogen with automatic on/off with automatic delay	●	●	–	–
– halogen with automatic on/off with automatic delay, projector-beam (requires available Luxury Package on LT)	–	○	●	●
Mirrors – manual-adjustable, manual-folding	●	–	–	–
– power-adjustable, manual-folding (requires available Custom Special Edition on WT)	○	●	–	–
– heated, power-adjustable, manual-folding (requires available LT Convenience Package on LT)	–	○	●	●
– Black caps (requires available Redline Edition on LT)	●	○	●	–
– body-color caps (requires available Custom Special Edition on WT)	○	●	–	●
– chrome caps (requires available Chrome Appearance Package)	–	○	–	–
– driver spotter mirror (requires available Custom Special Edition on WT)	○	●	●	●

	WT	LT	Z71	ZR2
<b>EXTERIOR (CONTINUED)</b>				
Moldings – Black beltline	●	●	●	●
– chrome beltline (requires available Chrome Appearance Package)	–	○	–	–
Recovery hooks <sup>1</sup> – front (standard on WT and LT 4x4 models)	●	●	●	–
– Red, front (requires available Redline Edition on LT)	–	○	○	●
Tailgate – locking	●	–	–	–
– EZ Lift with power lock and release (requires available WT Convenience Package on WT)	○	●	●	●
Tire – full-size spare, 255/65R17 all-season	●	●	●	–
– full-size spare, 265/65R17 all-terrain	–	–	–	●
Tires – 255/65R17 all-season	●	●	–	–
– 255/65R17 all-terrain	–	–	●	–
– 265/65R17 Goodyear Wrangler DuraTrac® all-terrain (requires available Z71 Midnight Edition on Z71)	–	–	○	●
– 265/60R18 all-season (requires available 18" Dark Argent Metallic-painted aluminum wheels on WT; requires available 18" Dark Argent Metallic-painted aluminum wheels or Redline Edition on LT)	○	○	–	–
Wheels – 17" Ultra Silver Metallic-painted steel	●	–	–	–
– 17" Blade Silver Metallic-painted aluminum	–	●	–	–
– 17" bright machined-aluminum	–	–	●	–
– 17" Graphite and Oxide Gold aluminum	–	–	–	●
– 17" high-gloss Black-painted aluminum (requires available Trail Boss Package)	–	○	○	–
– 17" gloss Black-painted aluminum (requires available Z71 Midnight Edition on Z71; requires available ZR2 Dusk Special Edition or ZR2 Midnight Special Edition on ZR2)	–	–	○	○
– 17" AEV-designed Dark Graphite aluminum (requires available ZR2 Bison Edition)	–	–	–	○
– 18" Dark Argent Metallic-painted aluminum; includes 265/60R18 all-season tires (requires available Custom Special Edition on WT)	○	○	–	–
– 18" Black-painted aluminum with Red accents (requires available Redline Edition)	–	○	–	–
ZR2 Off-Road Package – taller and wider stance, Multimatic DSSV™ Damping System, off-road front fascia and rear bumper, fender flares and Chevrolet lettered grille with small flowtie emblem	–	–	–	●

<sup>1</sup> To avoid the risk of injury, never use recovery hooks to tow a vehicle. For more information, see the Recovery Hooks section of your Owner's Manual.

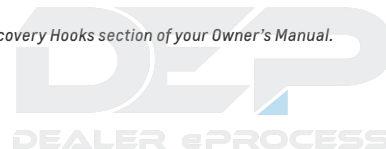

## SPECIFICATIONS (CONTINUED)

● STANDARD ○ AVAILABLE – NOT AVAILABLE

	WT	LT	Z71	ZR2
<b>INTERIOR</b>				
Air conditioning – manual, single-zone	●	●	–	–
– automatic, single-zone (requires available Luxury Package on LT)	–	○	●	●
Console – front center floor	●	●	●	●
– overhead with sunglasses holder	–	●	●	●
Cruise control – electronic with Set and Resume Speed (requires available WT Convenience Package on WT)	○	●	●	●
Defogger – rear-window (requires available LT Convenience Package on LT)	–	○	●	●
Door locks – power programmable with lockout protection and rear door child security	●	●	●	●
Driver Information Center – monochromatic display	●	●	–	–
– enhanced with multi-color display (requires available Chevrolet Infotainment 3 Plus system <sup>1</sup> with Navigation <sup>2</sup> on LT)	–	○	●	●
Floor covering – Black vinyl (deletes front and rear carpeted floor mats; not available with ZR2 Bison Edition on ZR2)	○	–	–	○
Floor mats – front and rear, carpeted (not available with ZR2 Bison Edition on ZR2)	●	●	●	●
Mirror – rearview, manual day/night	●	–	–	–
– rearview, auto-dimming	–	●	●	●
Remote Keyless Entry – extended-range (requires available WT Convenience Package on WT)	○	●	●	●
Remote vehicle starter system (requires available LT Convenience Package on LT)	–	○	●	●
Steering column – manual tilt	●	–	–	–
– manual tilt and telescopic	–	●	●	●
Steering wheel – leather-wrapped with mounted audio, cruise and phone controls	–	●	●	●
– heated (requires available heated front seats or Luxury Package on LT)	–	○	●	●
Visors – driver and front passenger, with passenger vanity mirror	●	–	–	–
– driver and front passenger, illuminated vanity mirrors	–	●	●	●
Window – sliding rear (requires available LT Convenience Package on LT)	–	○	●	●
Windows – power with driver express-up/-down, all others express-down	●	●	●	●

	WT	LT	Z71	ZR2
<b>SEATING</b>				
Seats – front bucket	●	●	●	●
– dual rear with underseat storage (Extended Cab models)	●	●	●	●
– rear seat delete (Extended Cab models) (requires available Black vinyl floor covering)	○	–	–	–
– rear folding bench (Crew Cab models)	●	●	●	●
Seat – driver 4-way manual adjuster	●	–	–	–
– driver 6-way power adjuster	–	●	●	●
– driver power lumbar control (requires available heated front seats or Luxury Package on LT)	–	○	●	●
– front passenger 4-way power adjuster and power lumbar control	–	–	–	●
Heated front seats – includes driver power lumbar control and heated steering wheel (models built on or after November 15, 2021, heated front seats will not function without dealer retrofit, expected Q2 2022; see dealer for details) (requires available LT Convenience Package on LT)	–	○	○	○

<sup>1</sup> Chevrolet Infotainment System functionality varies by model. Full functionality requires compatible Bluetooth and smartphone, and USB connectivity for some devices. <sup>2</sup> Map coverage available in the United States, Puerto Rico and Canada.

## SPECIFICATIONS (CONTINUED)

● STANDARD ○ AVAILABLE – NOT AVAILABLE

	WT	LT	Z71	ZR2
<b>ENTERTAINMENT</b>				
Chevrolet Infotainment 3 system <sup>1</sup> with 7-inch diagonal color touch-screen, AM/FM stereo, Bluetooth <sup>®</sup> audio streaming <sup>2</sup> for two active devices, voice command pass-through to compatible phone, and Apple CarPlay <sup>3</sup> and Android Auto <sup>™4</sup> compatibility	●	–	–	–
Chevrolet Infotainment 3 system <sup>1</sup> with 8-inch diagonal color touch-screen, AM/FM stereo, Bluetooth audio streaming <sup>2</sup> for two active devices, voice command pass-through to compatible phone, and Apple CarPlay <sup>3</sup> and Android Auto <sup>4</sup> compatibility	–	●	–	–
Chevrolet Infotainment 3 Plus system <sup>1</sup> with 8-inch diagonal HD color touch-screen, AM/FM stereo, Bluetooth audio streaming <sup>2</sup> for two active devices, voice command pass-through to compatible phone, Apple CarPlay <sup>3</sup> and Android Auto <sup>4</sup> compatibility, available Alexa Built-In <sup>5</sup> ; voice recognition, available In-Vehicle Apps <sup>6</sup> and Chevrolet Maps <sup>+7</sup>	–	–	●	●
Chevrolet Infotainment 3 Plus system <sup>1</sup> with Navigation <sup>8</sup> and 8-inch diagonal HD color touch-screen, AM/FM stereo, Bluetooth audio streaming <sup>2</sup> for two active devices, voice command pass-through to compatible phone, Apple CarPlay <sup>3</sup> and Android Auto <sup>4</sup> compatibility, available Alexa Built-In <sup>5</sup> SD card reader, enhanced voice recognition, additional memory for available In-Vehicle Apps <sup>6</sup> and Connected Navigation <sup>9</sup> ; includes Bose premium 7-speaker sound system; LT includes HD Rear Vision Camera <sup>10</sup> and enhanced multi-color Driver Information Center	–	○	○	○
Audio system – 6-speaker – Bose premium 7-speaker sound system (requires available Chevrolet Infotainment 3 Plus system <sup>1</sup> with Navigation <sup>8</sup> )	●	●	●	●
Media – two USB ports <sup>11</sup> and auxiliary input jack in front center floor console – two USB ports, <sup>11</sup> charge-only, on rear of front center floor console	●	●	●	●
SiriusXM <sup>®12</sup> – 3-month trial subscription	●	●	●	●
Available Wi-Fi <sup>®</sup> Hotspot <sup>13</sup> for up to seven devices, includes 1 month of unlimited data (requires available OnStar <sup>14</sup> on WT)	○	●	●	●
Chevrolet Connected Access <sup>15</sup> with 10 years of standard connectivity, which currently enables features such as Vehicle Diagnostics and Dealer Maintenance Notification (requires available OnStar <sup>14</sup> on WT)	○	●	●	●
Wireless charging <sup>16</sup>	–	–	○	○

<sup>1</sup> Chevrolet Infotainment System functionality varies by model. Full functionality requires compatible Bluetooth and smartphone, and USB connectivity for some devices. <sup>2</sup> Go to [my.chevrolet.com/learnAbout/bluetooth](http://my.chevrolet.com/learnAbout/bluetooth) to find out which phones are compatible with the vehicle. Full Bluetooth feature functionality varies by device, model and software version. <sup>3</sup> Vehicle user interface is a product of Apple and its terms and privacy statements apply. Requires compatible iPhone and data plan rates apply. <sup>4</sup> Vehicle user interface is a product of Google and its terms and privacy statements apply. Requires the Android Auto app on Google Play and a compatible Android smartphone. Data plan rates apply. You can check which smartphones are compatible at [g.co/androidauto/requirements](http://g.co/androidauto/requirements). <sup>5</sup> Functionality is subject to limitations and varies by vehicle, infotainment system and location. Select service plan required. Certain Alexa Skills require account linking to use. Visit [onstar.com](http://onstar.com) for additional details. <sup>6</sup> Third-party trademarks are the property of their respective third-party owners and used under agreement. Requires active service plan and paid AT&T vehicle data plan. Visit [onstar.com](http://onstar.com) for details and limitations. <sup>7</sup> U.S. only. Requires select service plan. Functionality is subject to user terms and limitations and varies by vehicle model. Visit [onstar.com](http://onstar.com) for details and limitations. <sup>8</sup> Map coverage available in the United States, Puerto Rico and Canada. <sup>9</sup> Connected Navigation and Real-time Points of Interest (POI) only available on properly equipped vehicles. Requires paid plan or trial. Map coverage available in the United States, Puerto Rico and Canada. Visit [onstar.com](http://onstar.com) for details and limitations. <sup>10</sup> Safety or driver assistance features are no substitute for the driver's responsibility to operate the vehicle in a safe manner. Read the vehicle Owner's Manual for important feature limitations and information. <sup>11</sup> Not compatible with all devices. <sup>12</sup> If you decide to continue service after your trial, your selected subscription plan will automatically renew thereafter. You will be charged at then-current rates. Fees and taxes apply. To cancel you must call SiriusXM at 1-866-635-2349. See SiriusXM Customer Agreement for complete terms at [siriusxm.com](http://siriusxm.com). All fees and programming subject to change. <sup>13</sup> Service varies with conditions and location. Requires active service and paid AT&T data plan. Visit [onstar.com](http://onstar.com) for details and limitations. Availability subject to change. <sup>14</sup> When you select a monthly plan within 30 days of activating your 1-month trial, you'll receive the next 2 months of the plan you select at no additional charge when you associate an approved payment method on file to your account and authorize recurring payments for your service plan. The amount and frequency of each recurring payment is based upon the service(s) and payment interval(s) you select from the options provided. After the trial expires, OnStar will automatically bill your payment method monthly at then-current standard monthly rates. Plans containing 4G LTE data will be billed every 30 days by AT&T. You may cancel at any time by pushing your blue OnStar button or calling 1-888-466-7827. May not be combined with other offers or retroactively applied. Offer subject to change. <sup>15</sup> Standard connectivity available only to original purchaser for up to 10 years. Connected Access services are subject to change. Does not include emergency or security services. Diagnostic capabilities vary by model and service plan. Message and data rates may apply. Requires contact method on file and enrollment to receive alerts. Not all issues will deliver alerts. Visit [onstar.com](http://onstar.com) for details and limitations. <sup>16</sup> The system wirelessly charges one compatible mobile device. Some phones have built-in wireless charging technology and others require a special adaptor/back cover. To check for phone or other device compatibility, see [my.chevrolet.com/learn](http://my.chevrolet.com/learn) or consult your carrier.



## SPECIFICATIONS (CONTINUED)



Custom Special Edition.



Redline Edition.

● STANDARD ○ AVAILABLE – NOT AVAILABLE

	WT	LT	Z71	ZR2
<b>PACKAGES AND SPECIAL EDITIONS</b>				
<b>Trailer Package</b>	○	○	○	●
Trailer hitch, 7-pin and 4-pin connectors, and Hitch Guidance <sup>1</sup> (standard on Crew Cab Long Box models; requires available 3.6L V6 engine and automatic locking rear differential on WT and LT; requires available Duramax 2.8L Turbo-Diesel I-4 engine on LT)				
<b>Custom Special Edition</b>	○	–	–	–
18" Dark Argent Metallic-painted aluminum wheels, 265/60R18 all-season tires, body-color center grille bar, rear bumper, door handles and mirror caps, and outside rearview mirror with driver spotter mirror				
<b>WT Convenience Package</b>	○	–	–	–
Remote Keyless Entry, theft-deterrent system with unauthorized entry, cruise control, and EZ Lift tailgate with power lock and release				
<b>Chrome Appearance Package</b>	–	○	–	–
Chrome center grille bar, heated power-adjustable manual-folding mirrors with chrome caps, chrome door handles, chrome beltline moldings and chrome rear bumper				
<b>LT Convenience Package</b>	–	○	–	–
Fog lamps, heated power-adjustable body-color mirrors, remote vehicle starter system and sliding rear window with defogger				
<b>Luxury Package (Crew Cab)</b>	–	○	–	–
Projector-beam halogen headlamps, driver power lumbar control, heated steering wheel, single-zone automatic climate control and heated front seats (heated front seats will not function on certain models without dealer retrofit, expected Q2 2022; see dealer for details) (requires available LT Convenience Package and leather-appointed front seating surfaces)				
<b>Redline Edition</b>	–	○	–	–
18" Black-painted aluminum wheels with Red accents, Black bowtie emblem, Black center grille bar, 3-inch round Black off-road assist steps, Black Out Exterior Trim Package, Black spray-on bedliner and Red recovery hooks <sup>2</sup> (available with Summit White, Satin Steel Metallic or Black exterior colors)				

<sup>1</sup> Safety or driver assistance features are no substitute for the driver's responsibility to operate the vehicle in a safe manner. Read the vehicle Owner's Manual for important feature limitations and information. <sup>2</sup> To avoid the risk of injury, never use recovery hooks to tow a vehicle. For more information, see the Recovery Hooks section of your Owner's Manual.

## SPECIFICATIONS (CONTINUED)

● STANDARD ○ AVAILABLE – NOT AVAILABLE



Trail Boss Package<sup>1</sup>



Z71 Midnight Edition.

	WT	LT	Z71	ZR2
<b>PACKAGES AND SPECIAL EDITIONS (CONTINUED)</b>				
<b>Trail Boss Package<sup>1</sup> (4x4 models)</b>	–	○	○	–
17" high gloss Black-painted aluminum wheels, Red recovery hooks, <sup>2</sup> Black tailgate lettering, Black Colorado badges, front 1" leveling kit, and Performance front and mid skid plates; includes Black bowtie emblems on LT				
<b>Safety Package</b>	–	○	○	–
Forward Collision Alert <sup>3</sup> and Lane Departure Warning; <sup>3</sup> includes Rear Park Assist <sup>3</sup> on LT (models built on or after December 20, 2021, Rear Park Assist will not function on certain models without dealer retrofit, expected Q4 2022; see dealer for details)				
<b>Z71 Midnight Edition</b>	–	–	○	–
Black exterior color, 17" gloss Black-painted aluminum wheels, Goodyear Wrangler DuraTrac <sup>®</sup> tires, Z71 door emblem, Black spray-on bedliner, and all-weather floor liner with Chevrolet logo				

<sup>1</sup> Limited availability. <sup>2</sup> To avoid the risk of injury, never use recovery hooks to tow a vehicle. For more information, see the Recovery Hooks section of your Owner's Manual. <sup>3</sup> Safety or driver assistance features are no substitute for the driver's responsibility to operate the vehicle in a safe manner. Read the vehicle Owner's Manual for important feature limitations and information.

## SPECIFICATIONS (CONTINUED)



ZR2 Bison Edition.



ZR2 Dusk Special Edition.



ZR2 Midnight Special Edition.

● STANDARD ○ AVAILABLE – NOT AVAILABLE

	WT	LT	Z71	ZR2
<b>PACKAGES AND SPECIAL EDITIONS (CONTINUED)</b>				
<b>ZR2 Bison Edition</b>	-	-	-	○
17" AEV-designed aluminum wheels and spare wheel, AEV front bumper with winch provisions and AEV rear bumper with recovery points, AEV hot-stamped boron steel skid plates for front differential, engine oil pan, transfer case, fuel tank and rear differential, AEV fender flares, fog lamps, front and rear floor liners with AEV logo, and AEV embroidered head restraints (available with Summit White, Satin Steel Metallic, Sand Dune Metallic, Crush <sup>1</sup> or Black exterior colors)				
<b>ZR2 Dusk Special Edition</b>	-	-	-	○
17" gloss Black-painted aluminum wheels and spare wheel, off-road lights, and sport bar with ZR2 logo				
<b>ZR2 Midnight Special Edition</b>	-	-	-	○
Black exterior color, 17" gloss Black-painted aluminum wheels and spare wheel, off-road lights, and sport bar with ZR2 logo				

<sup>1</sup>Extra-cost color.

## SPECIFICATIONS (CONTINUED)

### MAXIMUM CAPACITIES

	EXTENDED CAB	CREW CAB
Fuel tank (approximate)	21 gallons	21 gallons
Cargo volume <sup>1</sup>	49.9 cubic feet	41.3 cubic feet – Short Box 49.9 cubic feet – Long Box

### DIMENSIONS

	EXTENDED CAB	CREW CAB
<b>A</b> – Wheelbase	128.3" 128.5" – ZR2	128.3" – Short Box 128.5" – ZR2 140.5" – Long Box
<b>B</b> – Height	70.4" – 2WD 70.3" – 4x4 72.4" – ZR2	70.7" – 2WD Short Box 70.6" – 2WD Long Box, 4x4 Short Box 70.5" – 4x4 Long Box 72.5" – ZR2
<b>C</b> – Width	62.4" 65.9" – ZR2	62.4" 65.9" – ZR2

	EXTENDED CAB	CREW CAB
<b>D</b> – Length	212.7" 212.4" – ZR2	212.7" – Short Box 212.7" – ZR2 224.9" – Long Box
Front track	83.9"	83.9"
Rear track	62.4" 65.9" – ZR2	62.4" 65.9" – ZR2
<b>E</b> – Inside width between wheelhousings	44.4"	44.4"
<b>F</b> – Inside bed length at floor	74.0"	61.7" – Short Box 74.0" – Long Box
<b>G</b> – Bed width wall to wall	57.8"	57.8"

	EXTENDED CAB	CREW CAB
Head room (front/rear)	41.4"/36.7"	41.4"/38.3"
Leg room (front/rear)	45.0"/28.6"	45.0"/35.8"
Shoulder room (front/rear)	57.5"/57.3"	57.5"/56.2"
Hip room (front/rear)	55.0"/52.2"	55.0"/53.3"

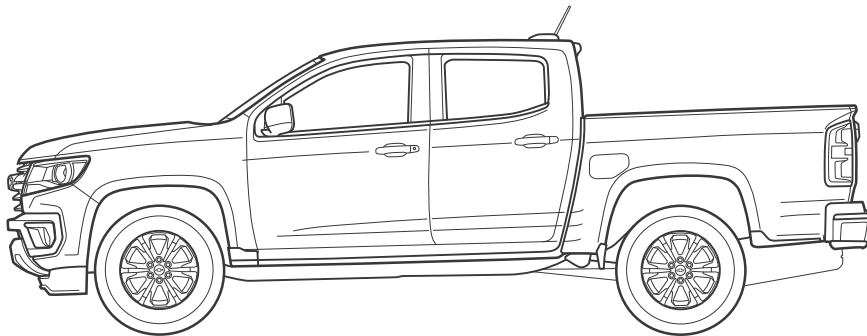

A



C

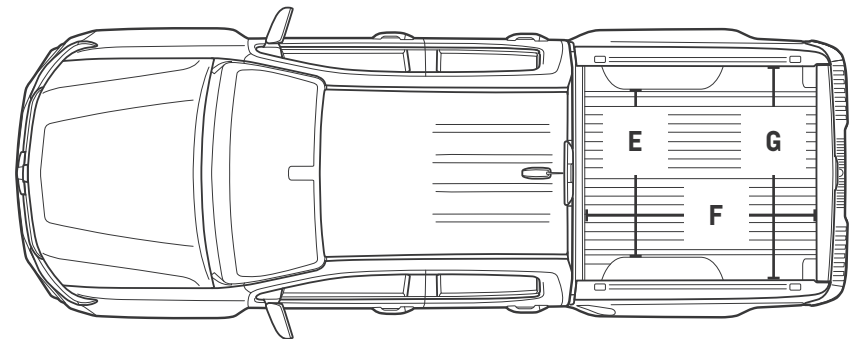

D

<sup>1</sup> Cargo and load capacity limited by weight and distribution.

## ACCESSORIES



All-Weather Floor Liners in Jet Black with Chrome Bowtie Logo available from Chevrolet Accessories.



Tonneau Cover available from Chevrolet Accessories.



Off-Road Assist Steps available from Chevrolet Accessories.



17" Gloss Black Aluminum Wheels<sup>1</sup> available from Chevrolet Accessories.

<sup>1</sup> Use only GM-approved wheel/tire combinations. See dealer for details.



## IMPORTANT INFORMATION



## Every step of the way.

You may be discovering Chevrolet through a personalized online shopping experience or enjoying every year of vehicle ownership. Either way, we're committed to providing the tools and programs you need to help you get the most out of your journey.

### Build & Price >

Create your perfect Chevrolet from start to finish.

### Chevy MyWay<sup>1</sup> >

Engage in a real-time virtual video experience with a Chevy product specialist.

### Chevrolet Complete Care >

Enjoy an owner benefit program that provides excellent service and support from day one.

### Chevy Truck Legends >

Honoring our dependable, long-lasting trucks and the people who keep them going strong.

### Limited Warranty Coverage >

Discover all the ways Chevrolet is committed to providing an excellent ownership experience.



GM, the GM logo, Chevrolet, the Chevrolet logo, and the slogans, emblems, vehicle model names, vehicle body designs and other marks appearing in this brochure are the trademarks and/or service marks of General Motors, its subsidiaries, affiliates or licensors. ©2022 OnStar LLC. All rights reserved. Sirius, XM, SiriusXM and all related marks and logos are trademarks of Sirius XM Radio Inc. Amazon, Alexa and all related marks are trademarks of Amazon.com, Inc. or its affiliates. The Bluetooth word mark is a registered trademark owned by Bluetooth SIG, Inc., and any use of such mark by Chevrolet is under license. Bose is a registered trademark of the Bose Corp. Goodyear and Wrangler DuraTrac are registered trademarks of The Goodyear Tire & Rubber Company.

©2022 General Motors. All rights reserved. January 2022

FIND NEW ROADS™

CHEVROLET.COM



<sup>1</sup> Chevy MyWay is available to anyone over 18 in the United States to access and experience via [chevrolet.com/myway](https://chevrolet.com/myway).